

REVISIONS			
REV	DESCRIPTION	SIGN	DATE
V1.0			03/28/00
			/ /
			/ /

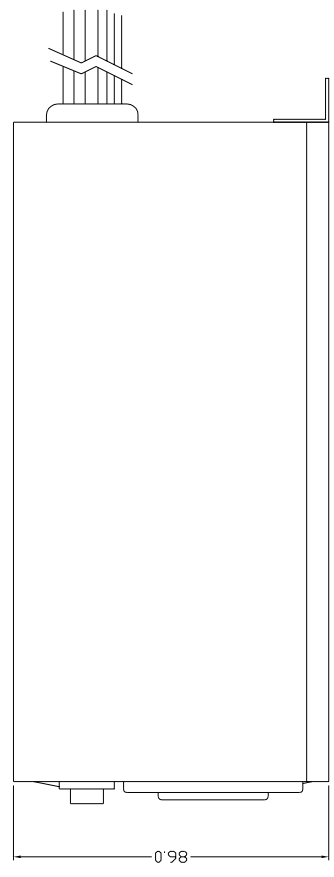

TOLERANCES		MATERIAL		UNIT		PART NO	
.X=	+/- 0.25	REMARK	SCLAE	mm	MODEL	TC-3UXX	
.XX=	+/- 0.100	APPD	DWG NO.	CKD	DRAWN	NAME	
						I=STAR COMPUTER	
					SHEET	DF	
					DATE		

PINOUPS OF CONNECTORS

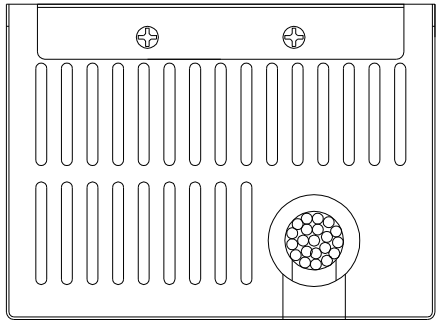
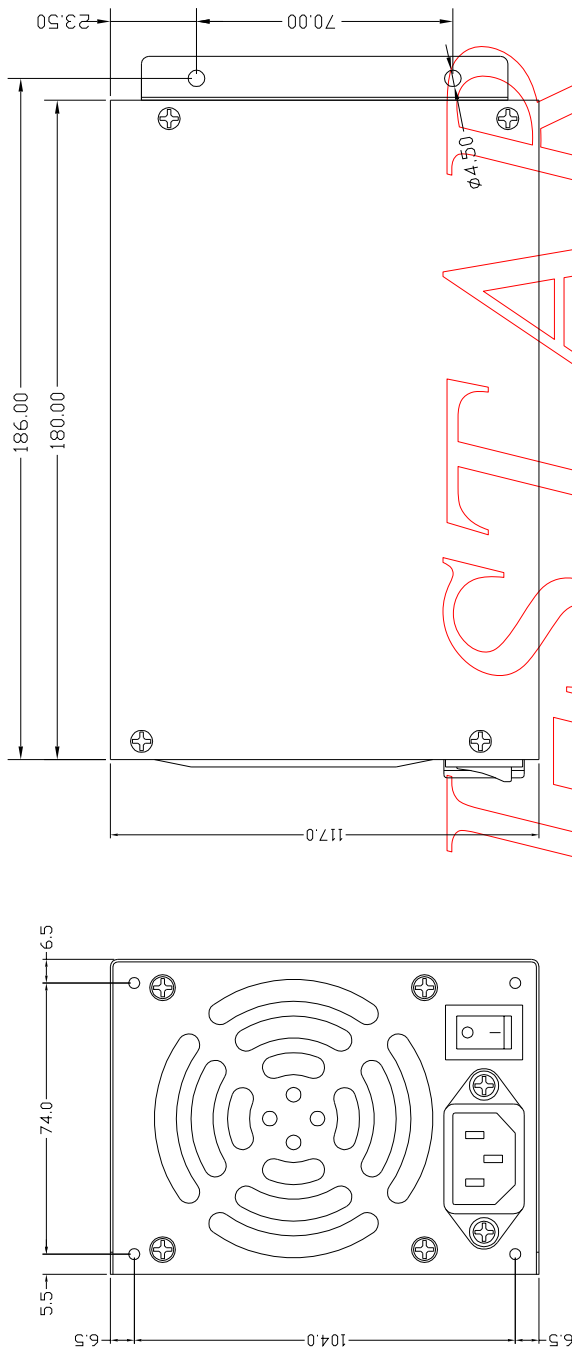
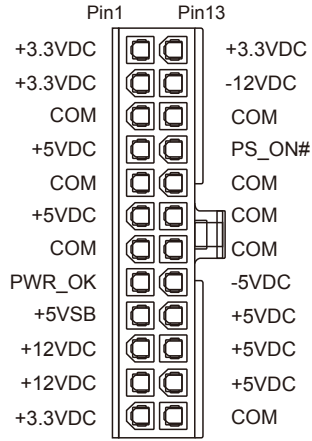

Main Power Connector

- | | | |
|----------------|-----------------|-------------|
| +12V = yellow | +5VSB = brown | -5V = white |
| +5V = red | PS_ON# = gray | -12V = blue |
| +3.3V = purple | PWR_OK = orange | COM = black |

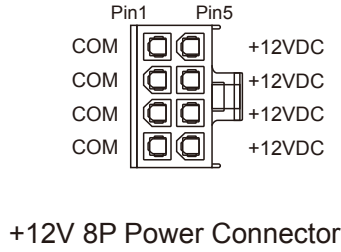

+12V 8P Power Connector

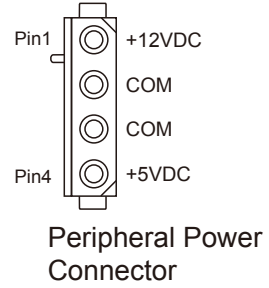

Peripheral Power Connector

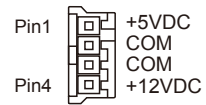

Floppy Drive Power Connector

